

Product Details

RS234L Sliding Access Cover

Technical Data

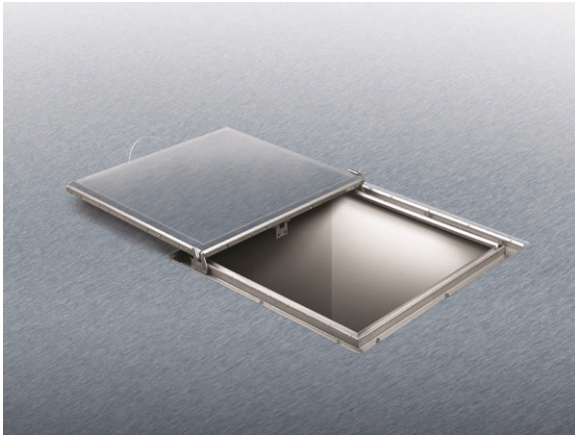

Dimensions:

834 x 984 overall size

33 - Overall Height

Materials - Stainless steel

Load Rating Class - K3

Weight - 34.2 kg

General Description:

Man Entry Sliding Access Cover, for use with flexible sheet floor covering (eg. vinyl) (Double Sealed Sliding Access Cover with 600 x 750 clear opening size; opening direction - length.). A watertight joint formed between the sheet floor covering and the edge of the frame, prevents water from seeping into the structure. Easy open sliding mechanism can be opened and closed safely by one person.

Options:

To specify an option, add option letter(s) as a suffix to the Spec. Code
H - fitted with Pin Torx screws for security applications

Materials:

Stainless Steel - Austenitic Grade 304 (Grade 316 optional on most products): Used for bodies, gratings, funnels, access covers, filter buckets and fixings. A corrosion-resistant metal containing significant amounts of nickel and chromium; AISI grade 304 stainless steel is used as standard, which is suitable for general use in and around buildings including most coastal locations. In applications such as swimming pools or having an aggressive atmosphere, grade 316 is recommended and is available optionally (if available, code 'M' will be listed under 'Options'). An even higher grade may be required for applications in highly corrosive environments including where exposure to seawater may be anticipated. Clean with soap and warm water rinse and wipe dry. Gratings may also be cleaned in certain dishwashers. Under no circumstances treat with metal scouring pads, metal scrapers or wire wool as these will contaminate surfaces leaving rust spots. Take care to cover stainless steel items when site work is going on, to avoid contamination with rust-inducing particles such as when mild steel or cast iron items are being cut.

All dimensions are in millimetres unless stated. In line with general practice all dimensions shown are nominal.

Wade International

Third Avenue, Halstead, Essex, CO9 2SX.

Telephone: +44 (0)1787 475151

Fax: +44 (0)1787 475579

e-mail: wadetech@alumascwms.co.uk

website: <https://www.alumascwms.co.uk/brands/wade/>

Typical Installation for RS234L:

Note: This illustration may show a similar Wade Product - it is intended to show the general installation type only.

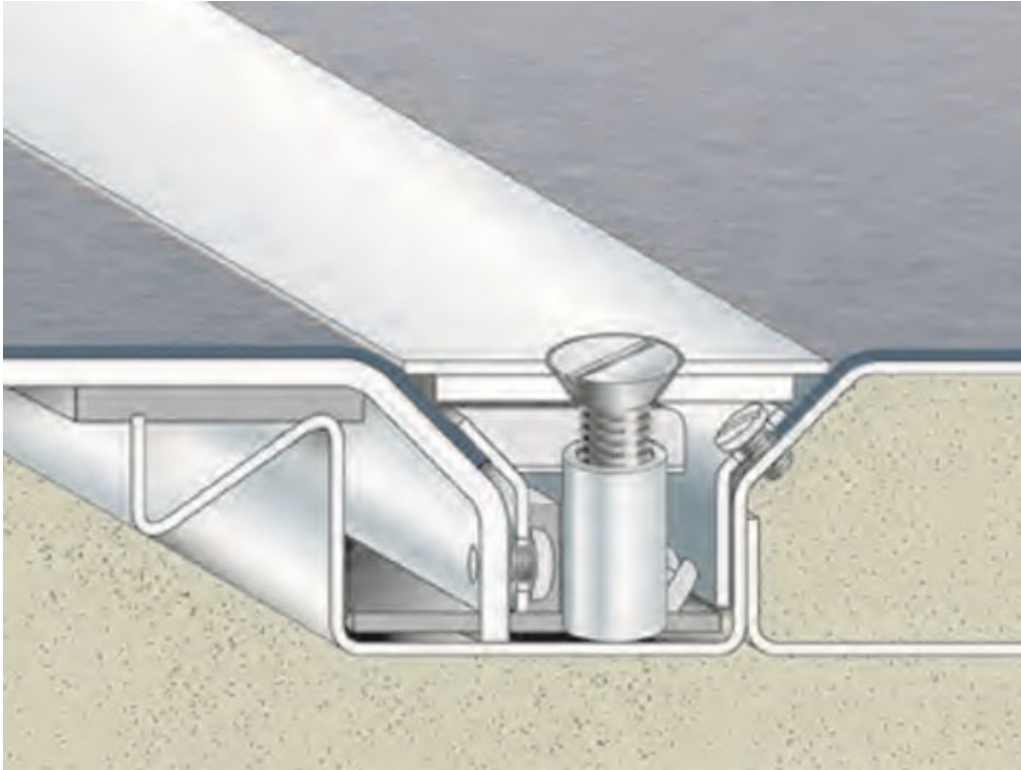

Dimensioned Section for RS234L:

