

Product Details

P413 Bell Trapped Gully Assembly

Technical Data

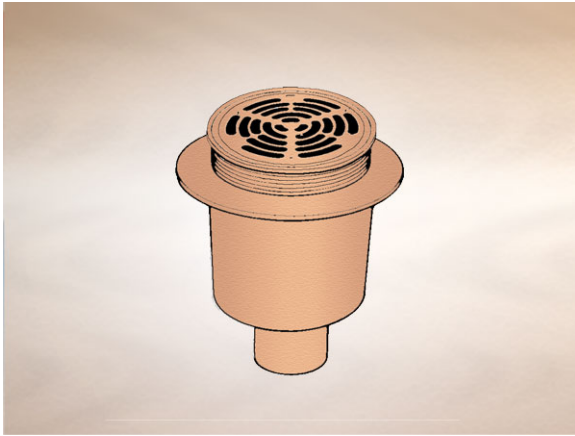

Dimensions:

230 dia. at finish level
325 dia. body
250 dia. overall size
316 - Height below Body Flange
0 to 75 - min/max height between top of grating and body flange

Connection - 3" Kunifer 10

Free Area - body= 44cm², grating= 106cm²

Materials - Cast gunmetal

Load Rating Class - L15

Weight - 28 kg

General Description:

Gunmetal Bell Trapped Gully Assembly, for use with flexible sheet floor covering (eg. vinyl), with 76 dia. vertical outlet. Non-spark gunmetal gullies with deep sump body are for use in metal decks such as on oil rigs and ships. Gratings are height adjustable by means of their thread, enabling installation at finished floor level.

Materials:

Gunmetal - BS EN 1982: Used for downspout nozzles, gratings, gunmetal gullies and non-freeze water points. A cast alloy suited to finished areas where the rich, bronze colour complements the decor. Being a non-spark material makes it particularly suited to gunmetal gullies for use in metal decks such as on oil rigs or ships. On certain products, a "mirror" finish is produced by polishing. If left alone polished bronze will gradually tarnish; to restore lustre, use metal polish and buff with a cloth. The mirror finish must not be treated with any abrasive cleaning material otherwise the surface will be permanently scratched. On other products, a satin finish with a fine grain effect is used which blends well with most floor finishes. The satin finish is generally maintained by the slight abrasive action of passing traffic. In unused areas the material will gradually tarnish. To restore lustre, apply a plain nylon scouring pad (not soap-filled) in the direction of grain.

All dimensions are in millimetres unless stated. In line with general practice all dimensions shown are nominal.

Wade International

Third Avenue, Halstead, Essex, CO9 2SX.

Telephone: +44 (0)1787 475151

Fax: +44 (0)1787 475579

e-mail: wadetech@alumascwms.co.uk

website: <https://www.alumascwms.co.uk/brands/wade/>

Dimensioned Section for P413:

