

Product Details

WF072 Reversible Outlet

Technical Data

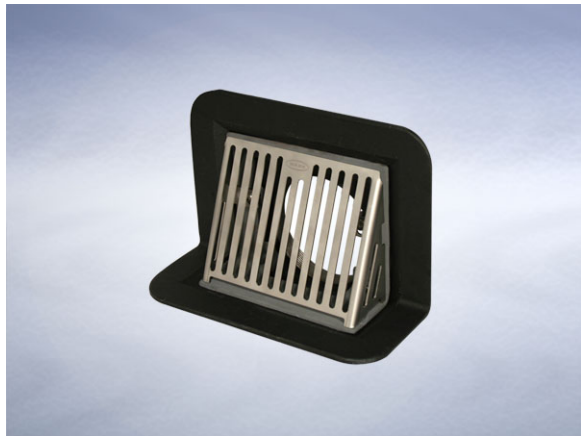

Dimensions:

166 x 139 at finish level
257 x 138 body
203 - Overall Height
39 - depth body flange to outlet center line

Connection - female 2" BSP threaded connection (50mm)

Materials - Grating - stainless steel; Body - cast iron, lacquered; Membrane Clamp - sherardized ductile iron

Weight - 5.6 kg

General Description:

166 x 139 Stainless Steel Parapet Reversible Outlet, with 2" BSP dia. horizontal outlet. Parapet outlet with reversible body to provide horizontal or vertical threaded outlet.

Options:

To specify an option, add option letter(s) as a suffix to the Spec. Code

G - gravel guard

M - grade 316 stainless steel

Materials:

Cast Iron - BS EN 1561: Used for bodies, membrane clamping collars, spigot adaptors and accessories such as extensions. A widely used metal in the drainage industry, its resistance to corrosion permits extended use under extreme conditions. Castings are coated with a high grade lacquer paint to provide internal and external surface coverage. Paint will gradually wear off and is replaceable; oxidisation (surface rusting) is a natural process which does not weaken the material. A zinc anti-corrosion coating is applied to certain castings by sherardizing.

Ductile Iron - BS EN 1563 + 1564: A casting with the ductility of steel, yet with more than twice the tensile strength of cast iron. A zinc anti-corrosion coating is applied by sherardizing.

Stainless Steel - Austenitic Grade 304 (Grade 316 optional on most products): Used for bodies, gratings, funnels, access covers, filter buckets and fixings. A corrosion-resistant metal containing significant amounts of nickel and chromium; AISI grade 304 stainless steel is used as standard, which is suitable for general use in and around buildings including most coastal locations. In applications such as swimming pools or having an aggressive atmosphere, grade 316 is recommended and is available optionally (if available, code 'M' will be listed under 'Options'). An even higher grade may be required for applications in highly corrosive environments including where exposure to seawater may be anticipated. Clean with soap and warm water rinse and wipe dry. Gratings may also be cleaned in certain dishwashers. Under no circumstances treat with metal scouring pads, metal scrapers or wire wool as these will contaminate surfaces leaving rust spots. Take care to cover stainless steel items when site work is going on, to avoid contamination with rust-inducing particles such as when mild steel or cast iron items are being cut.

All dimensions are in millimetres unless stated. In line with general practice all dimensions shown are nominal.

Wade International

Third Avenue, Halstead, Essex, CO9 2SX.

Telephone: +44 (0)1787 475151

Fax: +44 (0)1787 475579

e-mail: wadetech@alumascwms.co.uk

website: <https://www.alumascwms.co.uk/brands/wade/>

Typical Installation for WF072:

Note: This illustration may show a similar Wade Product - it is intended to show the general installation type only.

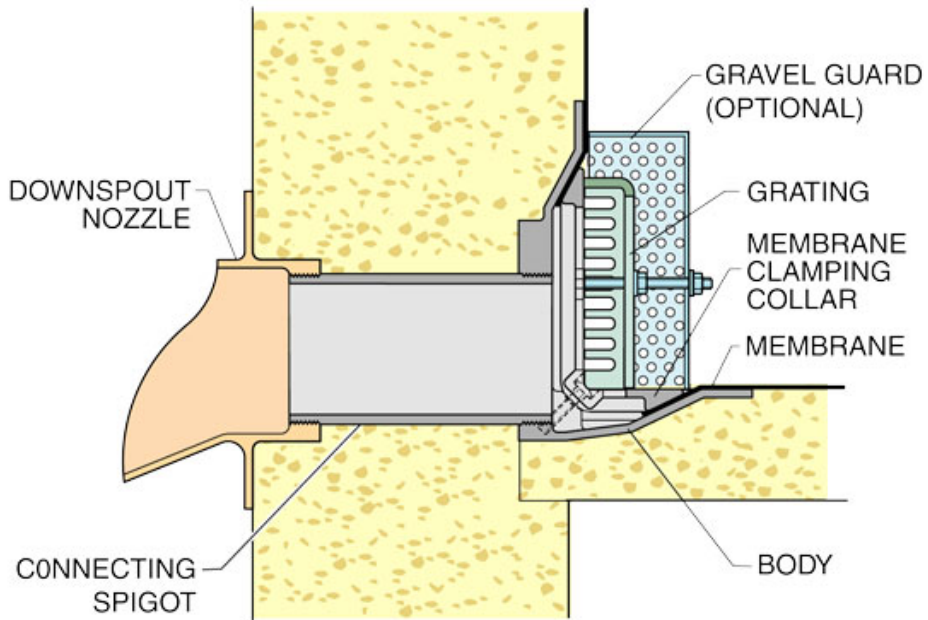

Dimensioned Section for WF072:

