

Product Details

WC332 Outlet with Circular Flat Grating

Technical Data

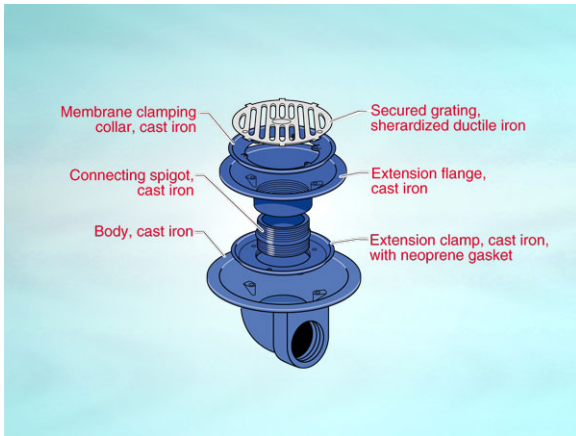

Dimensions:

220 dia. at finish level
305 dia. body
119 - Height below Body Flange
80 to 100 - min/max height between roof deck and membrane level

81 - depth body flange to outlet center line

Connection - female 2" BSP threaded connection (50mm)

Free Area - body= 19cm², grating= 130cm²

Materials - Grating - ductile iron, sherardized; Body - cast iron, lacquered; Membrane Clamp - cast iron, lacquered

Load Rating Class - L15

Weight - 13.3 kg

General Description:

220 Dia. Cast Iron 3400 series (Medium Sump) Warm Roof Outlet with Circular Flat Grating, for use with asphalt / composition finish, with 2" BSP dia. horizontal outlet. For other thicknesses of insulation, please contact our Technical Services Dept.

Options:

To specify an option, add option letter(s) as a suffix to the Spec. Code

K - bonded insulation jacket

Z - rigid PVC flange for use with PVC single ply membranes

Materials:

Cast Iron - BS EN 1561: Used for bodies, membrane clamping collars, spigot adaptors and accessories such as extensions. A widely used metal in the drainage industry, its resistance to corrosion permits extended use under extreme conditions. Castings are coated with a high grade lacquer paint to provide internal and external surface coverage. Paint will gradually wear off and is replaceable; oxidation (surface rusting) is a natural process which does not weaken the material. A zinc anti-corrosion coating is applied to certain castings by sherardizing.

Ductile Iron - BS EN 1563 + 1564: A casting with the ductility of steel, yet with more than twice the tensile strength of cast iron. A zinc anti-corrosion coating is applied by sherardizing.

All dimensions are in millimetres unless stated. In line with general practice all dimensions shown are nominal.

Wade International

Third Avenue, Halstead, Essex, CO9 2SX.

Telephone: +44 (0)1787 475151

Fax: +44 (0)1787 475579

e-mail: wadetech@alumascwms.co.uk

website: <https://www.alumascwms.co.uk/brands/wade/>

Typical Installation for WC332:

Note: This illustration may show a similar Wade Product - it is intended to show the general installation type only.

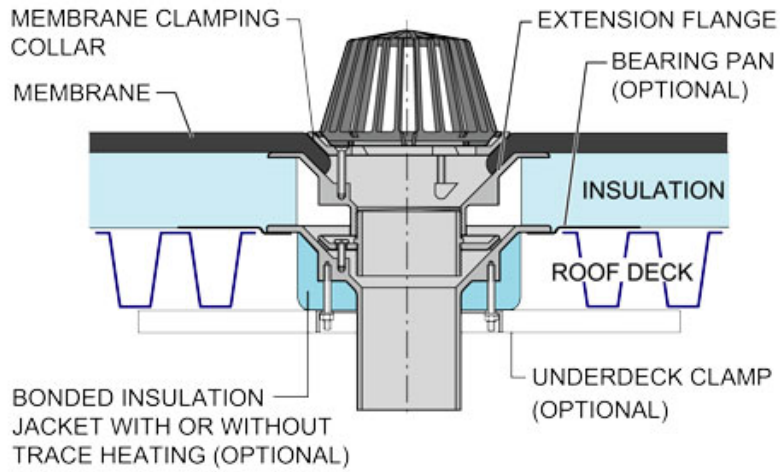

Dimensioned Section for WC332:

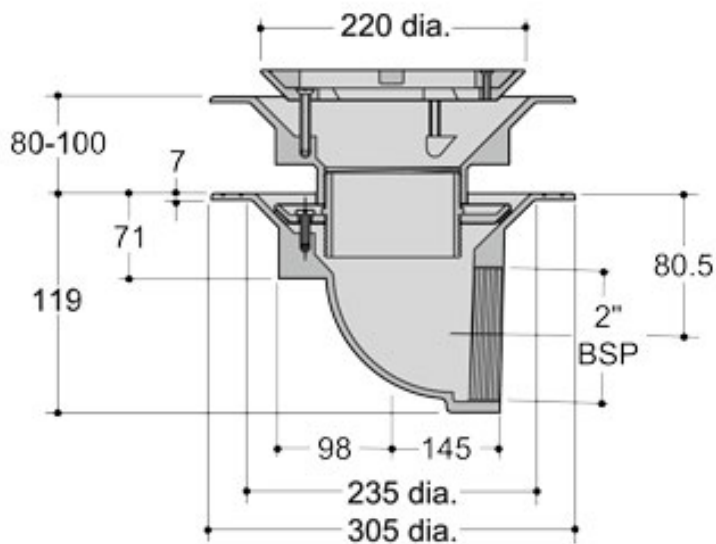

Flow Performance Figures for WC332:

Head of water at outlet	15mm	20mm	25mm	30mm	35mm	40mm	50mm
Flow Rate (l/s):	1.76	2.33	2.35	2.45	2.53	2.57	2.66
Roof area drained (m²) at 0.021 l/s per m² rainfall rate:	84	111	112	117	120	122	127

Note: Flow rates of Wade roof outlets have been established by full-scale tests. The values shown in the table are 75% of such tests. The design of the layout of roof outlets should be in accordance with the recommendations given in BS EN 12056:3.