

Product Details

WB223G1 Outlet with Circular Dome + Gravel Guard

Technical Data



Dimensions:

220 dia. at finish level
305 dia. body
90 - Height below Body Flange

Connection - female 3" BSP threaded connection (75mm)

Free Area - 44cm²

Materials - Gravel Guard - stainless steel; Dome - polycarbonate; Body - cast iron; Membrane Clamp - cast iron, lacquered

Load Rating Class - K3

Weight - 5.7 kg

General Description:

220 Dia. Stainless Steel 3400 series (Medium Sump) No Fines Screenshot / Inverted Roof Outlet with Circular Dome + Gravel Guard (150 high gravel guard), with 3" BSP dia. vertical outlet.

Options:

To specify an option, add option letter(s) as a suffix to the Spec. Code

K - bonded insulation jacket

SS - stainless steel dome

Materials:

Cast Iron - BS EN 1561: Used for bodies, membrane clamping collars, spigot adaptors and accessories such as extensions. A widely used metal in the drainage industry, its resistance to corrosion permits extended use under extreme conditions. Castings are coated with a high grade lacquer paint to provide internal and external surface coverage. Paint will gradually wear off and is replaceable; oxidation (surface rusting) is a natural process which does not weaken the material. A zinc anti-corrosion coating is applied to certain castings by sherardizing.

Polycarbonate: Used for domes. A polycarbonate/ABS blend which offers durability, high impact strength and long-term resistance to ultraviolet light.

Stainless Steel - Austenitic Grade 304 (Grade 316 optional on most products): Used for bodies, gratings, funnels, access covers, filter buckets and fixings. A corrosion-resistant metal containing significant amounts of nickel and chromium; AISI grade 304 stainless steel is used as standard, which is suitable for general use in and around buildings including most coastal locations. In applications such as swimming pools or having an aggressive atmosphere, grade 316 is recommended and is available optionally (if available, code 'M' will be listed under 'Options'). An even higher grade may be required for applications in highly corrosive environments including where exposure to seawater may be anticipated. Clean with soap and warm water rinse and wipe dry. Gratings may also be cleaned in certain dishwashers. Under no circumstances treat with metal scouring pads, metal scrapers or wire wool as these will contaminate surfaces leaving rust spots. Take care to cover stainless steel items when site work is going on, to avoid contamination with rust-inducing particles such as when mild steel or cast iron items are being cut.

All dimensions are in millimetres unless stated. In line with general practice all dimensions shown are nominal.

Wade International

Third Avenue, Halstead, Essex, CO9 2SX.

Telephone: +44 (0)1787 475151

Fax: +44 (0)1787 475579

e-mail: wadetech@alumascwms.co.uk

website: <https://www.alumascwms.co.uk/brands/wade/>

Typical Installation for WB223G1:

Note: This illustration may show a similar Wade Product - it is intended to show the general installation type only.

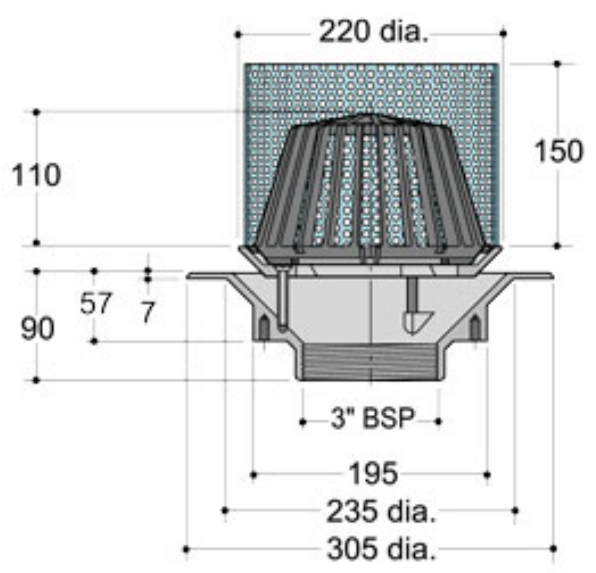
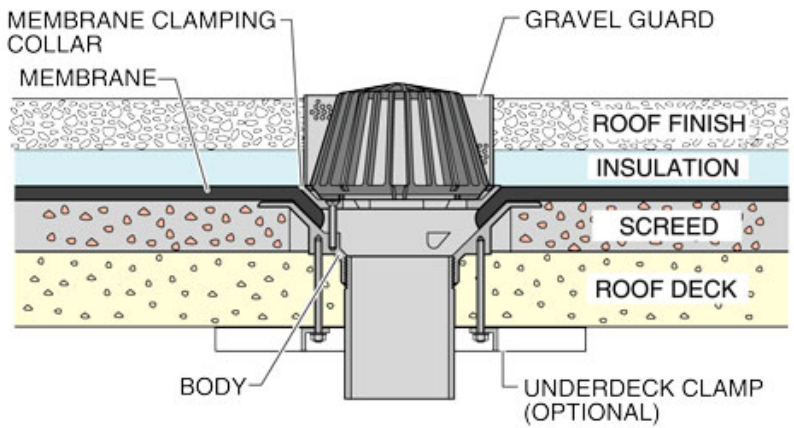

Flow Performance Figures for WB223G1:

Head of water at outlet	15mm	20mm	25mm	30mm	35mm	40mm	50mm
Flow Rate (l/s):	1.81	2.28	2.87	3.61	4.14	4.43	4.64
Roof area drained (m²) at 0.021 l/s per m² rainfall rate:	86	109	137	172	197	211	221

Note: Flow rates of Wade roof outlets have been established by full-scale tests. The values shown in the table are 75% of such tests. The design of the layout of roof outlets should be in accordance with the recommendations given in BS EN 12056:3.