

Product Details

6022LR Actimatic Grease Converter

Technical Data

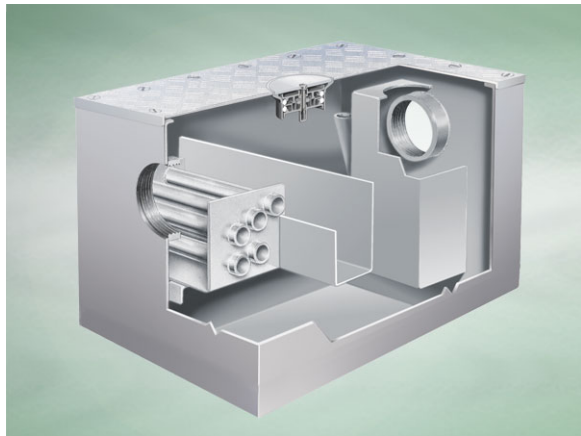

Dimensions:

482 x 775 overall size

330 - Overall Height

150 to 150 - 'C' dimension; centre line of pipework to top of tank

- depth body flange to outlet center line

Connection - female 2" BSP threaded connection (50mm)

Materials - Stainless steel

Weight - 70 kg

General Description:

Stainless Steel Low Profile Actimatic Grease Converter (Floor Standing - for use in Kitchens), with 2" BSP dia. horizontal outlet. A Wade Actimatic Grease Converter provides a NATURAL, safe and environmentally-friendly means of PERMANENTLY converting grease to bio-degradable products.

Materials:

Stainless Steel - Austenitic Grade 304 (Grade 316 optional on most products): Used for bodies, gratings, funnels, access covers, filter buckets and fixings. A corrosion-resistant metal containing significant amounts of nickel and chromium; AISI grade 304 stainless steel is used as standard, which is suitable for general use in and around buildings including most coastal locations. In applications such as swimming pools or having an aggressive atmosphere, grade 316 is recommended and is available optionally (if available, code 'M' will be listed under 'Options'). An even higher grade may be required for applications in highly corrosive environments including where exposure to seawater may be anticipated. Clean with soap and warm water rinse and wipe dry. Gratings may also be cleaned in certain dishwashers. Under no circumstances treat with metal scouring pads, metal scrapers or wire wool as these will contaminate surfaces leaving rust spots. Take care to cover stainless steel items when site work is going on, to avoid contamination with rust-inducing particles such as when mild steel or cast iron items are being cut.

All dimensions are in millimetres unless stated. In line with general practice all dimensions shown are nominal.

Wade International

Third Avenue, Halstead, Essex, CO9 2SX.

Telephone: +44 (0)1787 475151

Fax: +44 (0)1787 475579

e-mail: wadetech@alumascwms.co.uk

website: <https://www.alumascwms.co.uk/brands/wade/>

Typical Installation for 6022LR:

Note: This illustration may show a similar Wade Product - it is intended to show the general installation type only.

